

# OPERATION MANUAL

## M-thermal Wired Controller

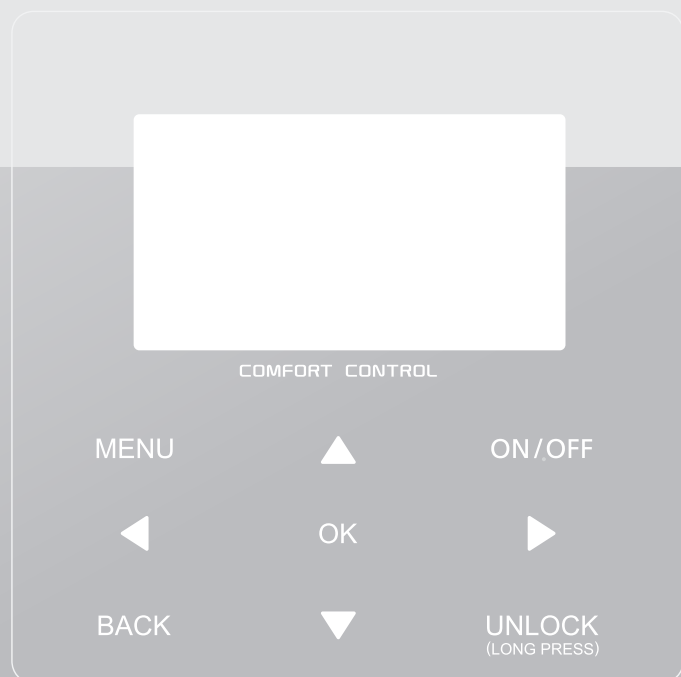

Thank you very much for purchasing our product,  
Before using your unit , please read this manual carefully and keep it for future reference.

- This manual gives detailed description of the precautions that should be brought to your attention during operation.
- In order to ensure correct service of the wired controller please read this manual carefully before using the unit.
- For convenience of future reference, keep this manual after reading it.

# CONTENTS

## 1 GENERAL SAFETY PRECAUTIONS

- 1.1 About the documentation ..... 01
- 1.2 For the user ..... 01

## 2 A GLANCE OF THE USER INTERFACE

- 2.1 The appearance of the wired controller ..... 02
- 2.2 Status icons ..... 02

## 3 USING HOME PAGES ..... 03

## 4 MENU STRUCTURE

- 4.1 About the menu structure ..... 05
- 4.2 To go to the menu structure ..... 05
- 4.3 To navigate in the menu structure ..... 05

## 5 BASIC USAGE

- 5.1 Screen Unlock ..... 05
- 5.2 Turning ON/OFF controls ..... 05
- 5.3 Adjusting the temperature ..... 07
- 5.4 Adjusting space operation mode ..... 08

## 6 OPERATION

- 6.1 Operation Mode ..... 08
- 6.2 Preset Temperature ..... 08
- 6.3 Domestic Hot Water(DHW) ..... 11
- 6.4 Schedule ..... 13
- 6.5 Options ..... 15
- 6.6 Child Lock ..... 18
- 6.7 Service Information ..... 18
- 6.8 Operation Parameter ..... 19
- 6.9 For Serviceman ..... 20
- 6.10 Network Configuration Guidelines ..... 21
- 6.11 SN VIEW ..... 23

## 7 MENU STRUCTURE : OVERVIEW ..... 24

# 1 GENERAL SAFETY PRECAUTIONS

## 1.1 About the documentation

- The precautions described in this document cover very important topics, follow them carefully.

### DANGER

Indicates a situation that results in death or serious injury.

### DANGER: RISK OF ELECTROCUTION

Indicates a situation that could result in electrocution.

### DANGER: RISK OF BURNING

Indicates a situation that could result in burning because of extreme hot or cold temperatures.

### WARNING

Indicates a situation that could result in death or serious injury.

### CAUTION

Indicates a situation that could result in minor or moderate injury.

### NOTE

Indicates a situation that could result in equipment or property damage.

### INFORMATION

Indicates useful tips or additional information.

## 1.2 For the user

- If you are not sure how to operate the unit, contact your installer.

- The appliance is not intended for use by persons, including children, with reduced physical, sensory or mental capabilities, or lack of experience and knowledge, unless they have been given supervision or instruction concerning use of the appliance by a person responsible for their safety. Children must be supervised to ensure that they do not play with the product.

### CAUTION

DO NOT rinse the unit. This may cause electric shocks or fire.

- Unit are marked with the following symbol:



This means that electrical and electronic products can not be mixed with unsorted household waste. Do NOT try to dismantle the system yourself: the dismantling of the system, treatment of the refrigerant, of oil and of other parts must be done by an authorized installer and must comply with applicable legislation. Units must be treated at a specialized treatment facility for reuse, recycling and recovery. By ensuring this product is disposed of correctly, you will help to prevent potential negative consequences for the environment and human health. For more information, contact your installer or local authority.

- Placed in a location away from radiation.

## 2 A GLANCE OF THE USER INTERFACE

### 2.1 The appearance of the wired controller

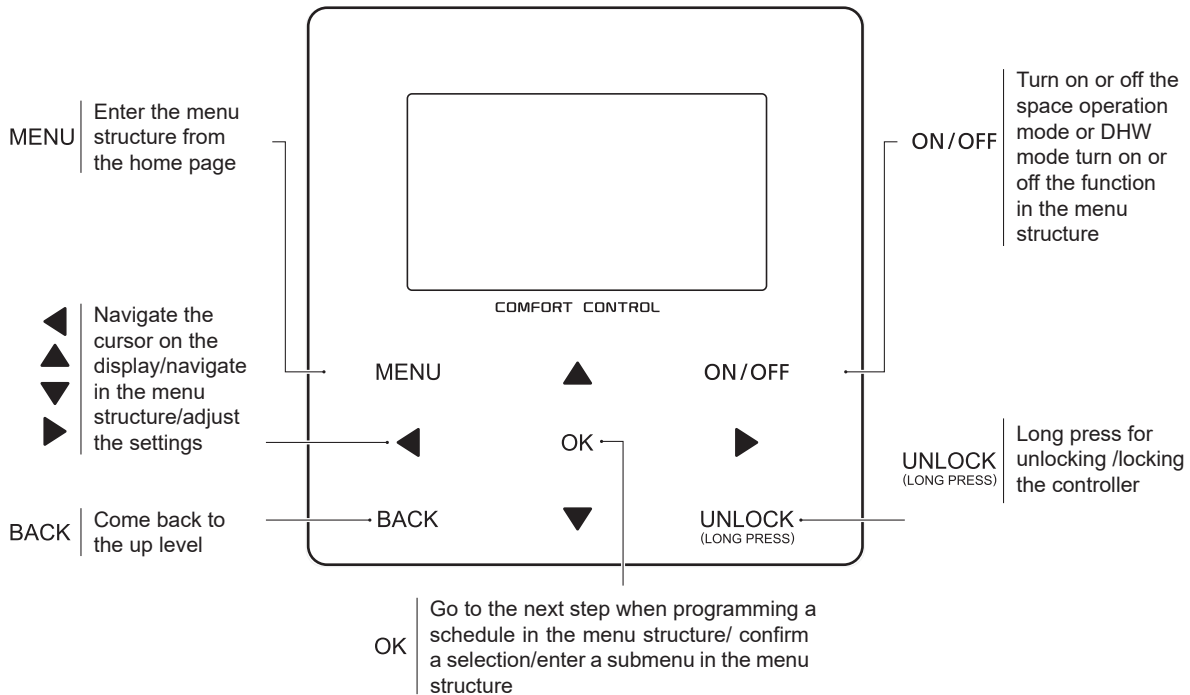

### 2.2 Status icons

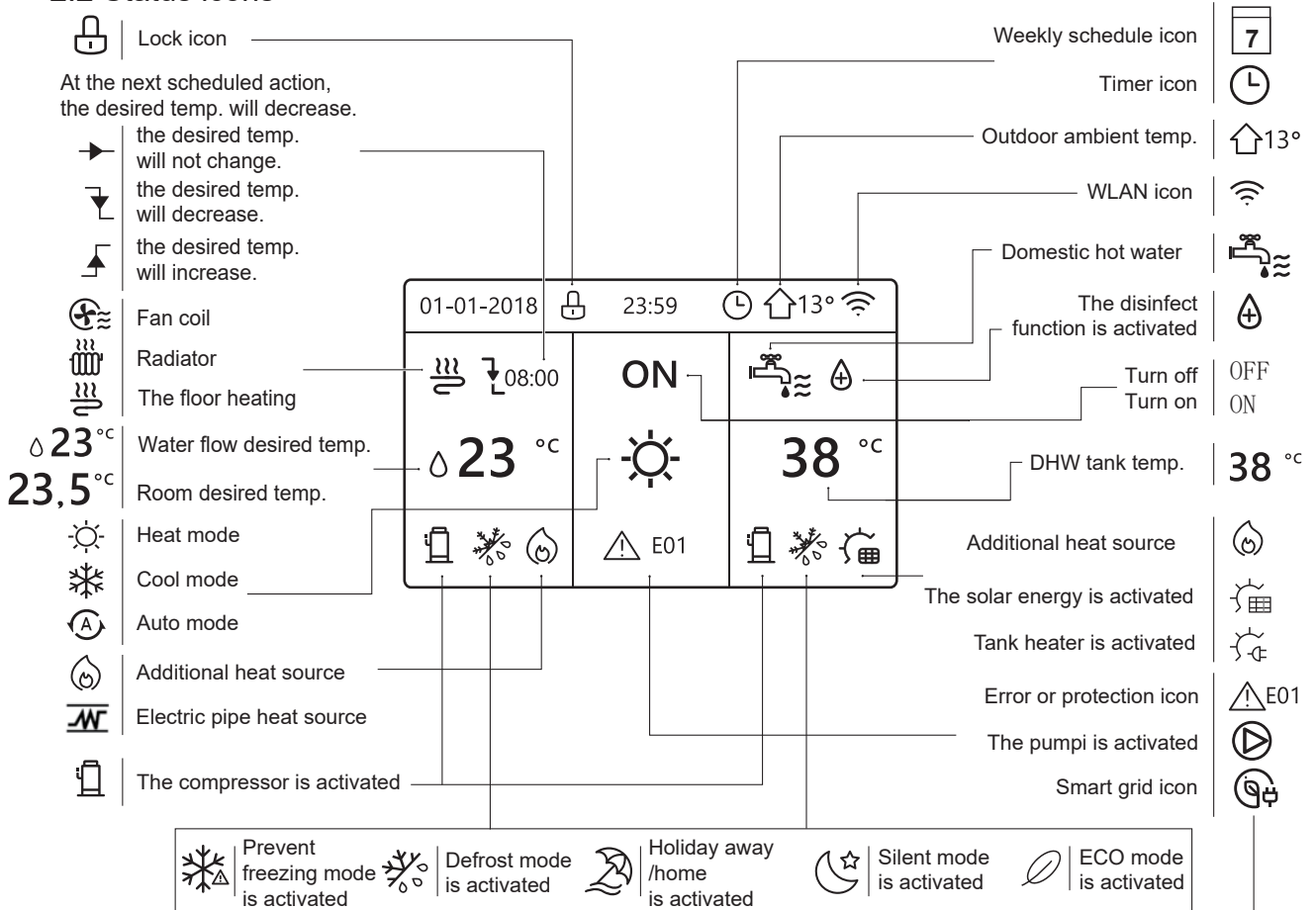

	Fan coil	Radiator	The floor heating	Domestic hot water
ON	🌀	🔥	🔥	🚰
OFF	⊕	🔥	🔥	🚰

	Free electricity	Valley electricity	Peak electricity
Smart grid	⚡	⚡	⚡

### 3 USING HOME PAGES

When you turn on the wired controller, the system will enter the language selection page, You can choose your preferred language, then press OK to enter the home pages. If you don't press OK in 60 seconds, the system will enter in the currently selected language.

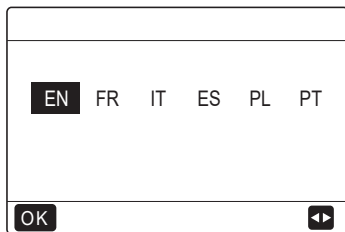

You can use the home pages to read out and change settings that are meant for daily usage. What you can see and do on the home pages is described where applicable. Depending on the system layout, the following home pages may be possible:

- Room desired temperature (ROOM )
- Water flow desired temperature (MAIN)
- DHW tank actual temperature (TANK) DHW=domestic hot water

#### home page1 :

If the WATER FLOW TEMP. is set YES and ROOM TEMP. is set NON.(See **"FOR SERVICEMAN" > "TEMP. TYPE SETTING"** in **"Installation and owner's manual"**). The system has the function including floor heating and domestic water, home page 1 will appear:

**the system layout 1**

#### NOTE

All the pictures in the manual are used to explain, the actual pages in the screen may have some difference.

#### home page2 :

If the WATER FLOW TEMP. is set NON and ROOM TEMP. is set YES(See **"FOR SERVICEMAN" > "TEMP. TYPE SETTING"** on **"Installation and owner's manual"**). The system has the function including floor heating and domestic hot water, home page 2 will appear:

**the system layout 2**

#### NOTE

The wired controller should be installed in the floor heating room to check the room temperature.

### home page3:

If the DHW MODE is set NON (See "FOR SERVICEMAN" > "DHW MODE SETTING " in "Installation and owner's manual ", and if "WATER FLOW TEMP." is set YES, "ROOM TEMP." is set YES,(See "FOR SERVICEMAN" > "TEMP. TYPE SETTING " in "Installation and owner's manual "). There will be main page and additional page. The system has the function including floor heating and space heating for fan coil, home page 3 will appear:

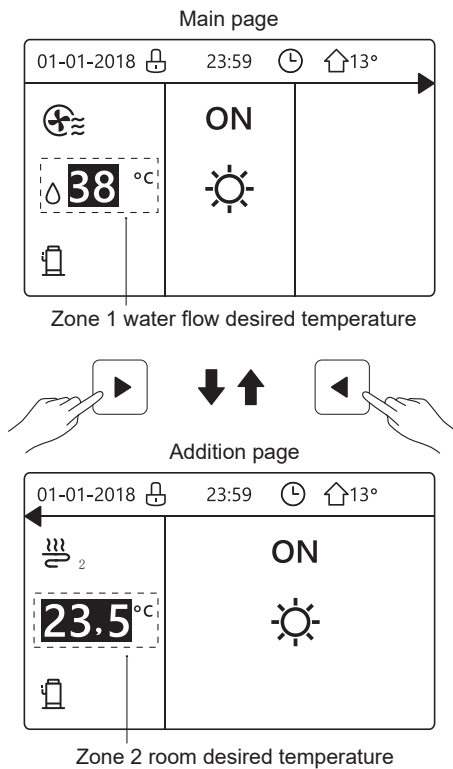

the system layout 3

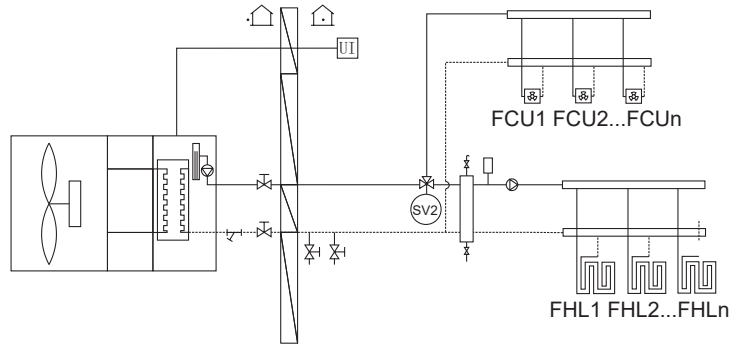

### home page4 :

If the ROOM THERMOSTAT is set DOUBLE ZONE or DOUBLE ZONE is set YES. There will be main page and addition page. The system has the function including floor cooling, space cooling for fan coil and domestic hot water, home page 4 will appear:

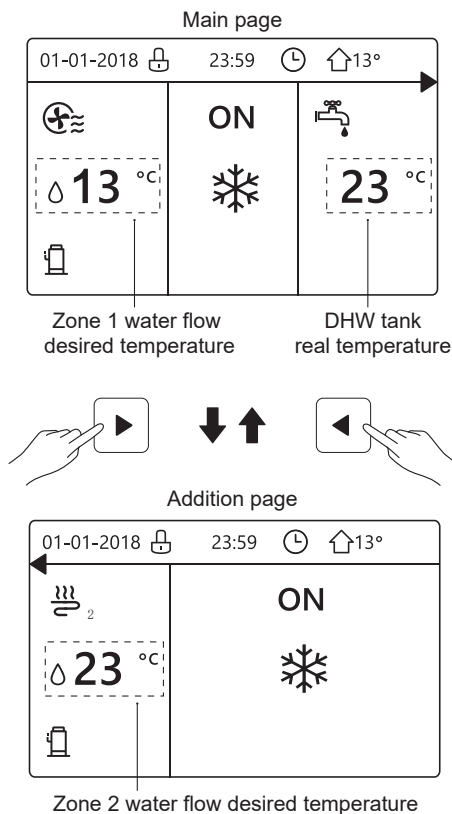

the system layout 4

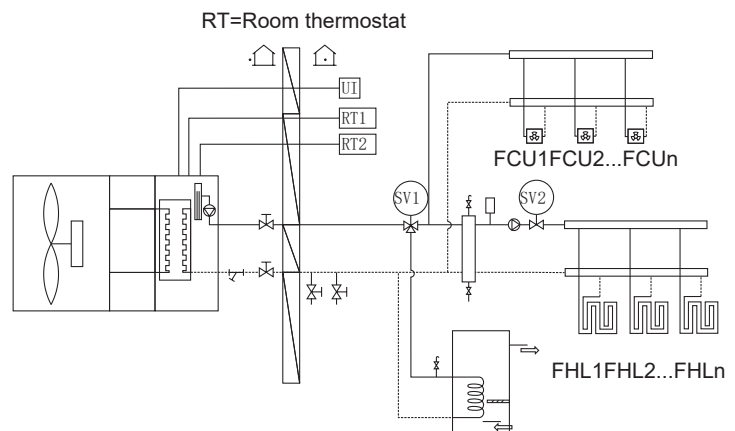

## 4 MENU STRUCTURE

### 4.1 About the menu structure

You can use the menu structure to read out and configure settings that are NOT meant for daily usage. What you can see and do in the menu structure is described where applicable. For an overview of the menu structure, see "7 Menu structure: Overview".

### 4.2 To go to the menu structure

From a home page, press "MENU".  
Result: The menu structure appear:

MENU	1/2
<b>OPERATION MODE</b>	
PRESET TEMPERATURE	
DOMESTIC HOT WATER(DHW)	
SCHEDULE	
OPTIONS	
CHILD LOCK	
<b>OK</b> ENTER	

MENU	2/2
<b>SERVICE INFORMATION</b>	
OPERATION PARAMETER	
FOR SERVICEMAN	
WLAN SETTING	
SN VIEW	
<b>OK</b> ENTER	

### 4.3 To navigate in the menu structure

Use "▼", "▲" to scroll.

## 5 BASIC USAGE

### 5.1 Screen Unlock

If the icon is on the screen, the controller is locked. The following page is displayed:

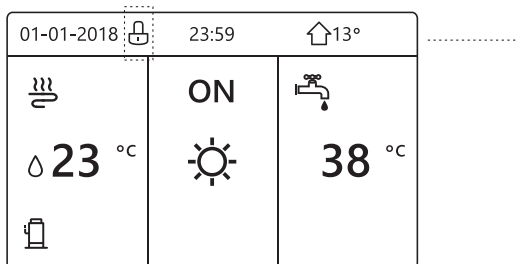

Press any key, the icon will flash. Long press the "UNLOCK" key. The icon will disappear, the interface can be controlled.

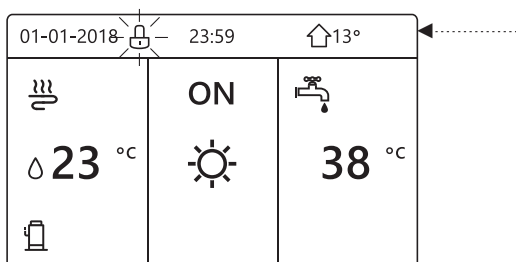

The interface will be locked if there is no handling for a long time (about 120 seconds; it can be set by the interface, see "6.7 SERVICE INFORMATION".)

If the interface is unlocked, long press "unlock", the interface will be locked.

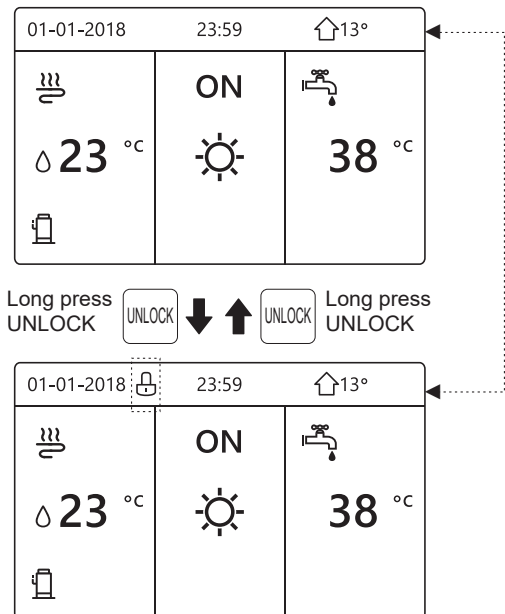

### 5.2 Turning ON/OFF controls

Use the interface to turn on or off the unit for space heating or cooling.

- The ON/OFF of the unit can be controlled by the interface if the ROOM THERMOSTAT is NON. (see "ROOM THERMOSTAT SETTING" in "Installation and owner's manual")

- Press "◀", "▲" on home page, the black cursor will appear:

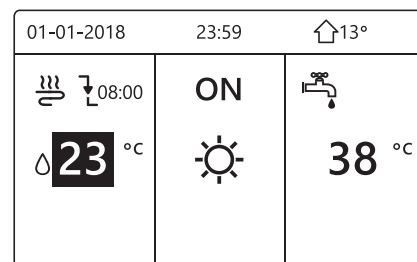

1) When the cursor is on the temperature of space operation mode side (including heat mode , cool mode and auto mode , press "ON/OFF" key to turn on/off space heating or cooling.

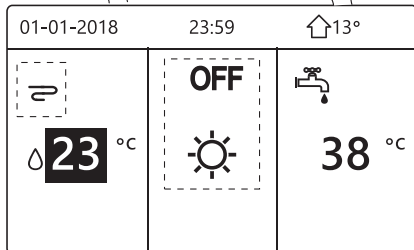
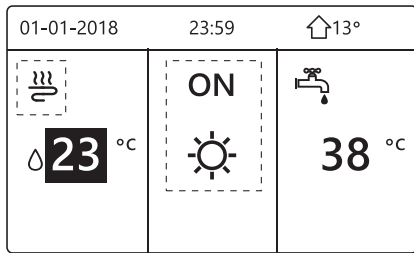

If the DHW TYPE is set NON, then following pages will display:

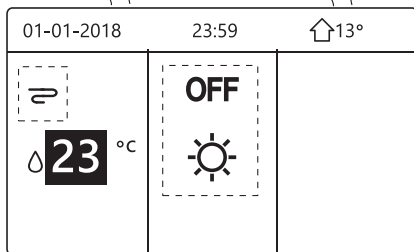
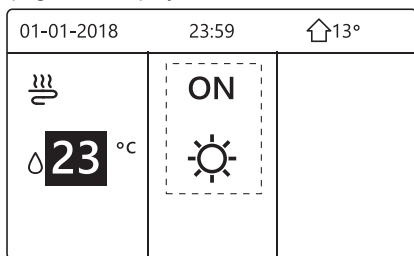

If the TEMP. TYPE is set ROOM TEMP. , then following pages will display:

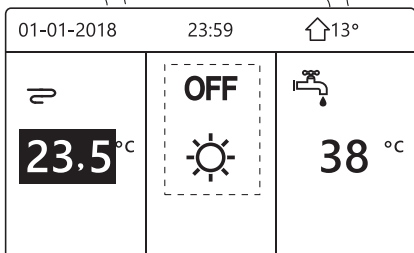
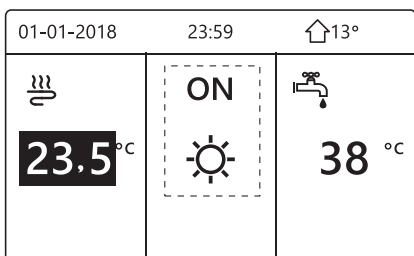

Use the room thermostat to turn on or off the unit for space heating or cooling.

- The room thermostat is not SET NON(see "ROOM THERMOSTAT SETTING" in "Installation and owner's manual "). The unit for space heating or cooling is turned on or off by the room thermostat, press ON/OFF on the interface, the following page will display:

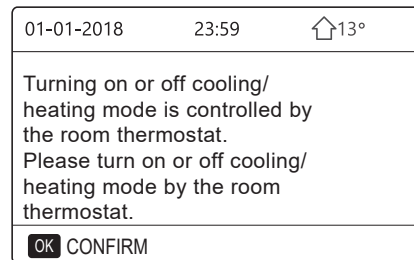

- The room thermostat is SET DOUBLE ZONE(see "ROOM THERMOSTAT SETTING" in "Installation and owner's manual "). The room thermostat for fan coil is turned off, the room thermostat for the floor heating is turned on, and the unit is running, but the display is OFF. The following page is displayed:

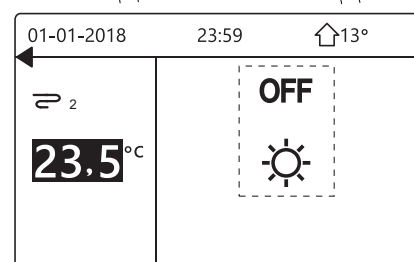
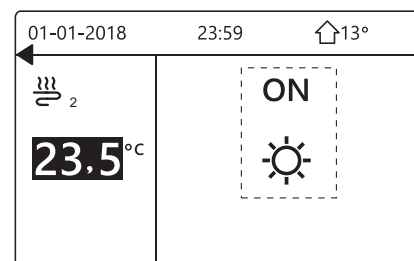
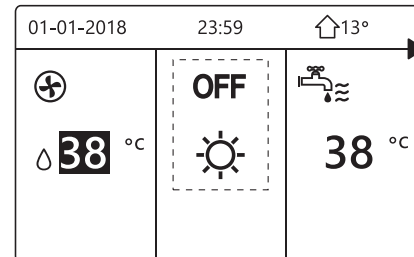
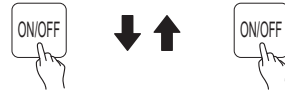
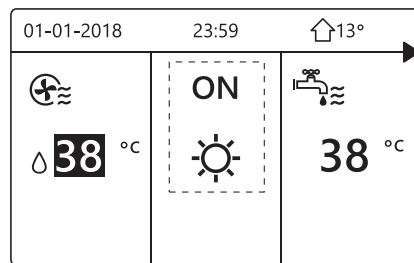



Use the interface to turn on or off the unit for DHW. Press "►", "▼" on home page, the black cursor will appear:

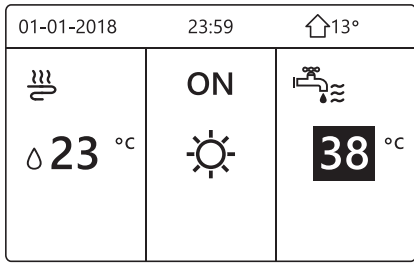

2) When the cursor is on the temperature of DHW mode. Press "ON/OFF" key to turn on/off the DHW mode.

If the space operation mode is ON, then following pages will display:

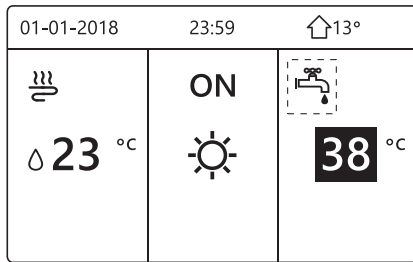
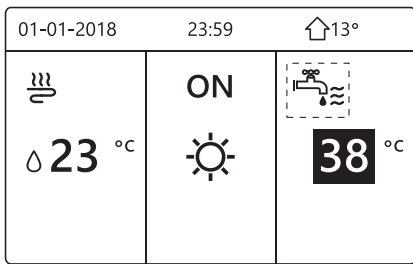

If the space operation mode is OFF, then following pages will display:

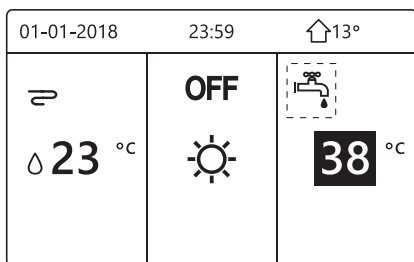
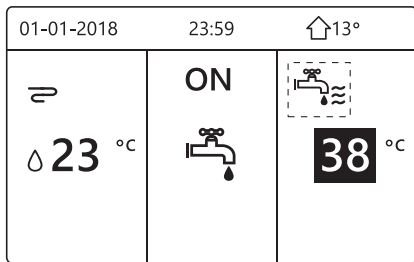

### 5.3 Adjusting the temperature

Press "◀", "▲" on home page, the black cursor will appear:

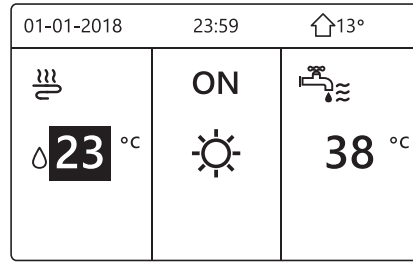

- If the cursor is on the temperature, use the "◀", "►" to select and use "▼", "▲" to adjust the temperature.

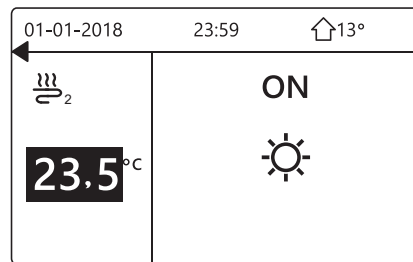
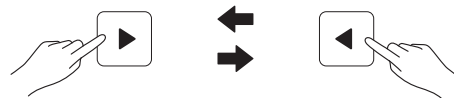
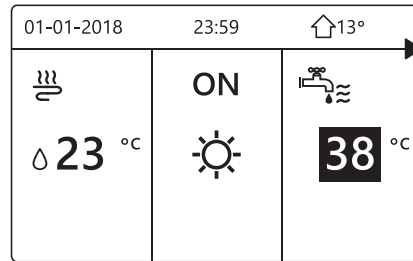
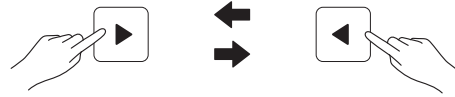
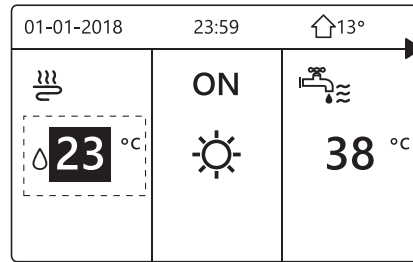

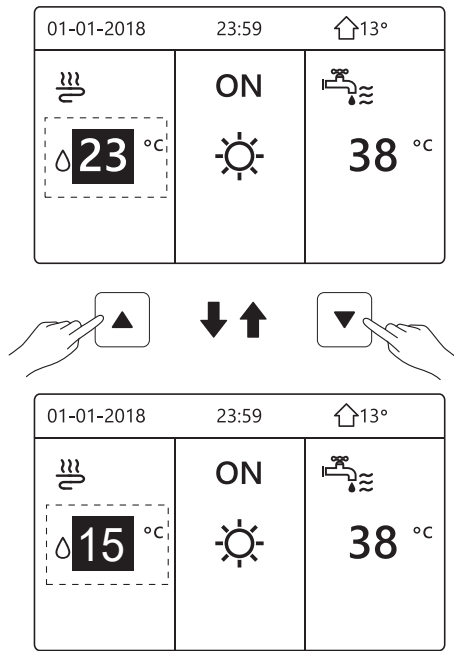

## 5.4 Adjusting space operation mode

- Adjusting space operation mode by interface  
Go to "MENU" > "OPERATION MODE". Press "OK", the following page will appear:

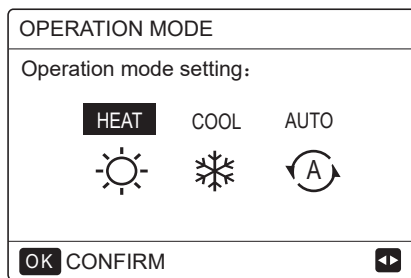

- There are three modes to be selected including HEAT, COOL and AUTO mode. Use the "◀", "▶" to scroll, press "OK" to select. Even you don't press OK button and exit the page by pressing BACK button, the mode would still be effective if the cursor had been moved to the operation mode.

If there is only HEAT(COOL) mode, the following page will appear:

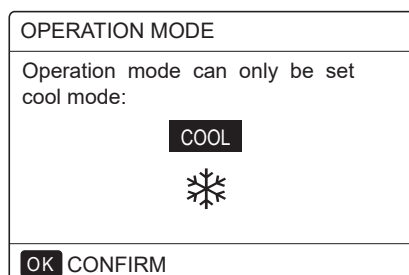
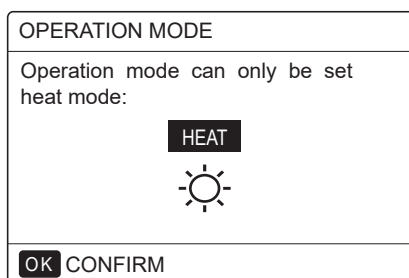

- The operation mode can not be changed.

If you select...	Then the space operation mode is...
 HEAT	Always heating mode
 COOL	Always cooling mode
 AUTO	Automatically changed by the software based on the outdoor temperature (and depending on installer settings of the indoor temperature), and takes monthly restrictions into account. Note: Automatic changeover is only possible under certain conditions. See the "FOR SERVICEMAN"> "AUTO MODE SETTING" in "Installation and owner's manual".

- Adjust space operation mode by the room thermostat , see "ROOM THERMOSTAT" on "Installation and owner's manual".  
Go to "MENU">"OPERATION MODE", if you press any key to select or adjust, the page will appear:

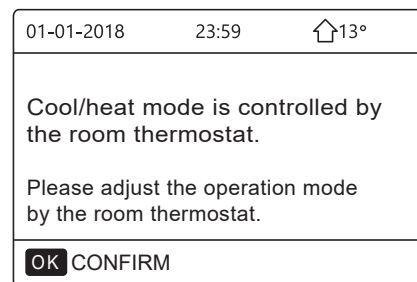

## 6 OPERATION

### 6.1 Operation Mode

See "5.4 Adjusting space operation mode"

### 6.2 Preset Temperature

PRESET TEMPERATUER has PRESET TEMP.\ WEATHER TEMP. SET\ECO MODE 3 items.

#### 6.2.1 PRESET TEMP.

PRESET TEMP. function is used to set different temperature on different time when the heat mode or cool mode is on.

- PRESET TEMP. =PRESET TEMPERATUER
- The PRESET TEMP. function will be off in these conditions.

- AUTO mode is running.
- TIMER or WEEKLY SCHEDULE is running.

- Go to "MENU" > "PRESTE TEMPERATURE" >"PRESET TEMP". Press "OK".

The following page will appear:

PRESET TEMPERATURE			1/2
PRESET TEMP.	WEATHER TEMP.SET	ECO MODE	
NO.	TIME	TEMP.	
1	<input type="checkbox"/>	00:00	25°C
2	<input type="checkbox"/>	00:00	25°C
3	<input type="checkbox"/>	00:00	25°C

PRESET TEMPERATURE			2/2
PRESET TEMP.	WEATHER TEMP.SET	ECO MODE	
NO.	TIME	TEMP.	
4	<input type="checkbox"/>	00:00	25°C
5	<input type="checkbox"/>	00:00	25°C
6	<input type="checkbox"/>	00:00	25°C

When double zone is activated, The PRESET TEMP. function only works for zone 1.

use "◀", "▶", "▼", "▲" to scroll and use "▼", "▲" to adjust the time and the temperature.

When the cursor is on "■", as the following page:

PRESET TEMPERATURE			1/2
PRESET TEMP.	WEATHER TEMP.SET	ECO MODE	
NO.	TIME	TEMP.	
1	<input checked="" type="checkbox"/>	00:00	25°C
2	<input type="checkbox"/>	00:00	25°C
3	<input type="checkbox"/>	00:00	25°C

OK  SELECT

You press "OK", and the "■" becomes "☑". The timer 1 is selected.

You press "OK" again, and the "☑" becomes "■". The timer 1 is unselected.

PRESET TEMPERATURE			1/2
PRESET TEMP.	WEATHER TEMP.SET	ECO MODE	
NO.	TIME	TEMP.	
1	<input checked="" type="checkbox"/>	08:00	35°C
2	<input checked="" type="checkbox"/>	12:00	25°C
3	<input checked="" type="checkbox"/>	15:00	35°C

OK  CANCEL

Use "◀", "▶", "▼", "▲" to scroll and use "▼", "▲" to adjust the time and the temperature. Six periods and six temperatures can be set.

For example: Now time is 8:00 and temperature is 30°C. We set the PRESET TEMP as following table. The following page will appear:

01-01-2018			8:00	↑ 13°
☁	↑ 08:00	ON		
💧	25 °C	☀		
🔋				

NO.	TIME	TEMPER
1	8:00	35°C
2	12:00	25°C
3	15:00	35°C
4	18:00	25°C
5	20:00	35°C
6	23:00	25°C

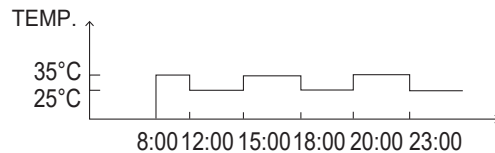

### INFORMATION

When the space operation mode is changed, the PRESET TEMP. is off automatically.

The PRESET TEMP. function can be used in the heat mode or cool mode. But if the operation mode is changed, the PRESET TEMP. function needs to be reset again.

The running preset temperature is valid when the unit is OFF. It will run according to the next preset temperature when the unit turn on again.

### 6.2.2 WEATHER TEMP. SET

- WEATHER TEMP. SET=WEATHER TEMPERATURE SET

- WEATHER TEMP.SET function is used to preset the desired water flow temperature depending on the outside air temperature. During the warmer weather the heating is reduced. To save energy, the weather temp.set can decrease the desired water flow temperature when the outdoor air temperature increased in heating mode.

Go to "MENU" > "PRESET TEMPERATURE" > "WEATHER TEMP. SET". Press "OK".

The following page will appear:

PRESET TEMPERATURE		
PRESET TEMP.	WEATHER TEMP.SET	ECO MODE
ZONE1 C-MODE LOW TEMP.		OFF
ZONE1 H-MODE LOW TEMP.		OFF
ZONE2 C-MODE LOW TEMP.		OFF
ZONE2 H-MODE LOW TEMP.		OFF
ON/OFF		ON/OFF

### **i** INFORMATION

• WEATHER TEMP. SET have four kinds of curves :1.the curve of the high temperature setting for heating,2.the curve of the low temperature setting for heating, 3.the curve of the high temperature setting for cooling ,4.the curve of the low temperature setting for cooling. It only have the curve of the high temperature setting for heating, if the high temperature is set for heating.

It only have the curve of the low temperature setting for heating, if the low temperature is set for heating.

It only have the curve of the high temperature setting for cooling, if the high temperature is set for cooling.

It only have the curve of the low temperature setting for cooling, if the low temperature is set for cooling.

• See "FOR SERVICEMAN"> "COOL MODE SETTING" and > "HEAT MODE SETTING" in "Installation and owner's manual".

• The desired temperature (T1S) can't be adjusted, when the temperature curve is set ON.

- If you want to use heat mode in zone 1 ,you select "ZONE1 H-MODE LOW TEMP". If you want to use cool mode in zone 1, you select "ZONE1 C-MODE LOW TEMP". If you select "ON", the following page will appear:

WEATHER TEMP. SET	
WEATHER TEMP. SET TYPE:	
1	2
3	4
5	6
7	8
9	
OK CONFIRM	

Use '◀', '▶' to scroll .Press "OK" to select.

PRESET TEMPERATURE		
PRESET TEMP.	WEATHER TEMP.SET	ECO MODE
ZONE1 C-MODE LOW TEMP		ON
ZONE1 H-MODE LOW TEMP		OFF
ZONE2 C-MODE LOW TEMP		OFF
ZONE2 H-MODE LOW TEMP		OFF
ON/OFF		ON/OFF

- If the weather TEMP.SET is activated,the desired temperature can not be adjusted on the interface.Press the "▼", "▲" to adjust the temperature on home page. The following page will appear:

01-01-2018	23:59	↑13°
Weather temp.set function is on. Do you want to turn off it?		
NO		YES
OK CONFIRM		

Move to "NO",press "OK" to come back to home page,move to "YES",press "OK" to reset the WEATHER TEMP. SET.

PRESET TEMPERATURE		
PRESET TEMP.	WEATHER TEMP.SET	ECO MODE
ZONE1 C-MODE LOW TEMP		OFF
ZONE1 H-MODE LOW TEMP		OFF
ZONE2 C-MODE LOW TEMP		OFF
ZONE2 H-MODE LOW TEMP		OFF
ON/OFF		ON/OFF

### 6.2.3 ECO MODE

ECO MODE is used to save energy. Go to "MENU" > "PRESET TEMPERATURE" > "ECO MODE". Press "OK" . The following page will appear:

PRESET TEMPERATURE		
PRESET TEMP.	WEATHER TEMP.SET	ECO MODE
CURRENT STATE		OFF
ECO TIMER		OFF
START		08:00
END		19:00
ON/OFF		ON/OFF

Press "ON/OFF" . The following page will appear:

ECO MODE SET	
ECO MODE SET TYPE:	
1	2
3	4
5	6
7	8
9	
OK CONFIRM	

Use "◀", "▶" to scroll. Press "OK" to select. The following page will appear:

PRESET TEMPERATURE	
PRESET TEMP.	WEATHER TEMP.SET
	<b>ECO MODE</b>
<b>CURRENT STATE</b>	ON
ECO TIMER	OFF
START	08:00
END	19:00
ON/OFF ON/OFF	

Use "ON/OFF" to turn ON or OFF, and use "▼", "▲" to scroll.

PRESET TEMPERATURE	
PRESET TEMP.	WEATHER TEMP.SET
	<b>ECO MODE</b>
CURRENT STATE	OFF
ECO TIMER	ON
START	08:00
END	19:00
ADJUST	

When the cursor is on the "START" or on the "END", you can use "◀", "▶", "▼", "▲" to scroll and use "▼", "▲" to adjust the time.

### INFORMATION

- ECO MODE SET have two kinds of curves :1.the curve of the high temperature setting for heating,2.the curve of the low temperature setting for heating, It only have the curve of the high temperature setting for heating, if the high temperature is set for heating.  
It only have the curve of the low temperature setting for heating, if the low temperature is set for heating.
- See "FOR SERVICEMAN">"HEAT MODE SETTING" in "Installation and owner's manual".
- The desired temperature (T1S) can't be adjusted, when the ECO mode is ON.
- You can select the low or high temperature setting for heating to see the "Table 1~2".
- If ECO MODE is ON and ECO TIMER is OFF, the unit runs ECO mode all the time.
- If ECO MODE is ON and ECO TIMER is ON, the unit runs ECO mode according to the start time and end time.

## 6.3 Domestic Hot Water(DHW)

DHW mode typically consists of the following :

- 1) DISINFECT
- 2) FAST DHW
- 3) TANK HEATER
- 4) DHW PUMP

### 6.3.1 Disinfect

The DISINFECT function is used to kill the legionella. In the disinfect function, the tank temperature will be reached 65~70°C forcibly. The disinfect temperature is set in FOR SERVICEMAN. See "FOR SERVICEMAN" > "DHW MODE" > "DISINFECT" in "Installation and owner's manual (M-thermal split indoor unit)".

Go to "MENU" > "DOMESTIC HOT WATER" > "DISINFECT". Press "OK". The following page will appear:

DOMESTIC HOT WATER (DHW)			
DIS-INFECT	FAST DHW	TANK HEATER	DHW PUMP
			<b>CURRENT STATE</b>
			ON
OPERATE DAY			FRI
START			23:00
ON/OFF ON/OFF			



DOMESTIC HOT WATER (DHW)			
DIS-INFECT	FAST DHW	TANK HEATER	DHW PUMP
			<b>CURRENT STATE</b>
			OFF
OPERATE DAY			FRI
START			23:00
ON/OFF ON/OFF			

Use "◀", "▶", "▼", "▲" to scroll and use "▼", "▲" to adjust the parameters when setting "OPERATE DAY" and "START". If the OPERATE DAY is set FRIDAY and the START is set 23:00, the disinfect function will activate on 23:00 Friday. If the disinfect function is running, the following page will appear:

01-01-2018	23:59	13°
	ON	
23.5°C		38°C

### 6.3.2 Fast DHW

The FAST DHW function is used to force the system to operate in DHW mode.

The heat pump and the booster heater or addition heater will operate for DHW mode together, and the DHW desired temperature will be changed to 60 C.

Go to MENU> DOMESTIC HOT WATER >FAST DHW. Press "OK":

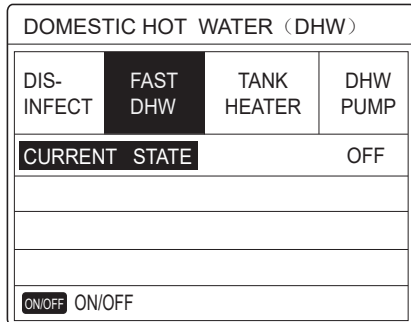
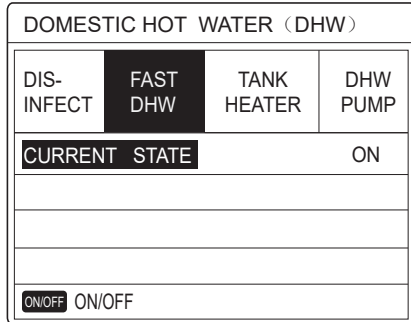

Use "ON/OFF" key to select ON or "OFF".

#### **i** INFORMATION

If CURRENT STATE is OFF, the FAST DHW is invalid, and if CURRENT STATE is ON, the FAST DHW function is effective. The FAST DHW function is once effective.

### 6.3.3 TANK HEATER

The tank heater function is used to force the tank heater to heat the water in tank. In the same situation, the cooling or heating is required and the heat pump system is operating for cooling or heating, however there still is a demand for the hot water.

Also, even if the heat pump system fails, TANK HEATER can be used to heat water in tank.

Go to "MENU" > "DOMESTIC HOT WATER" > "TANK HEATER". Press "OK".

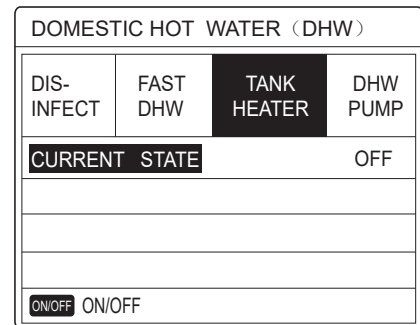
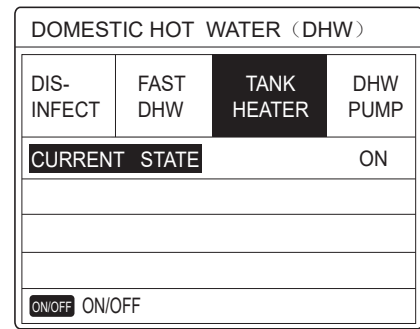

Use "ON/OFF" to select ON or OFF. Use "BACK" to exit.

If TANK HEATER is effect, the following page will appear:

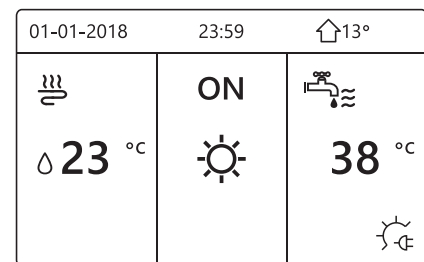

#### **i** INFORMATION

If CURRENT STATE is OFF, TANK HEATER is invalid. If the T5(sensor of tank) is fault ,tank heater can't work.

### 6.3.4 DHW Pump

The DHW PUMP function is used to return water of the water net. Go to "MENU" > "DOMESTIC HOT WATER" > "DHW PUMP". Press "OK". The following page will appear:

DOMESTIC HOT WATER (DHW) 1/2			
DIS-INFECT	FAST DHW	TANK HEATER	DHW PUMP
NO.	START	NO.	START
T1 <input type="checkbox"/>	00:00	T4 <input type="checkbox"/>	00:00
T2 <input type="checkbox"/>	00:00	T5 <input type="checkbox"/>	00:00
T3 <input type="checkbox"/>	00:00	T6 <input type="checkbox"/>	00:00

DOMESTIC HOT WATER (DHW) 2/2			
DIS-INFECT	FAST DHW	TANK HEATER	DHW PUMP
NO.	START	NO.	START
T7 <input type="checkbox"/>	00:00	T10 <input type="checkbox"/>	00:00
T8 <input type="checkbox"/>	00:00	T11 <input type="checkbox"/>	00:00
T9 <input type="checkbox"/>	00:00	T12 <input type="checkbox"/>	00:00

Move to "■", press "OK" to select or unselect. (  the timer is selected.  the timer is unselected.)

DOMESTIC HOT WATER (DHW) 1/2			
DIS-INFECT	FAST DHW	TANK HEATER	DHW PUMP
NO.	START	NO.	START
T1 <input checked="" type="checkbox"/>	00:00	T4 <input type="checkbox"/>	00:00
T2 <input type="checkbox"/>	00:00	T5 <input type="checkbox"/>	00:00
T3 <input type="checkbox"/>	00:00	T6 <input type="checkbox"/>	00:00

Use "◀", "▶", "▼", "▲" to scroll and use "▼", "▲" to adjust the parameters.

For example: you have set the parameter about the DHW PUMP (See "FOR SERVICEMAN" > "DHW MODE SETTING" on "Installation and owner's manual"). PUMP RUNNING TIME is 30 minutes.

Set as follows:

NO.	START
1	6:00
2	7:00
3	8:00
4	9:00

The PUMP will run as follows:

PUMP

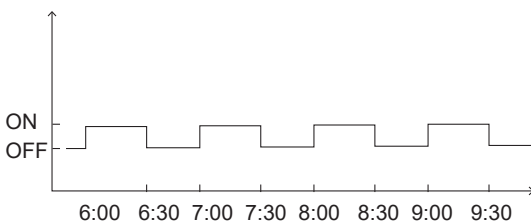

## 6.4 Schedule

SCHEDULE menu contents as follows:

- 1) TIMER
- 2) WEEKLY SCHEDULE
- 3) SCHEDULE CHECK
- 4) CANCEL TIMER

### 6.4.1 Timer

If the weekly schedule function is on, the timer is off, the later setting is effective. If the Timer is activated, ⌚ is displayed on home page.

SCHEDULE 1/2				
TIMER	WEEKLY SCHEDULE	SCHEDULE CHECK	CANCEL TIMER	
NO.	START	END	MODE	TEMP
1 <input type="checkbox"/>	00:00	00:00	HEAT	0°C
2 <input type="checkbox"/>	00:00	00:00	HEAT	0°C
3 <input type="checkbox"/>	00:00	00:00	HEAT	0°C

SCHEDULE 2/2				
TIMER	WEEKLY SCHEDULE	SCHEDULE CHECK	CANCEL TIMER	
NO.	START	END	MODE	TEMP
4 <input type="checkbox"/>	00:00	00:00	HEAT	0°C
5 <input type="checkbox"/>	00:00	00:00	HEAT	0°C
6 <input type="checkbox"/>	00:00	00:00	HEAT	0°C

- Use "◀", "▶", "▼", "▲" to scroll and use "▼", "▲" to adjust the time, the mode and the temperature.

Move to "■", press "OK" to select or unselect. (  the timer is selected.  the timer is unselected.) six timers can be set.

If you want to cancel the TIMER, you move the cursor to "■", press "OK", the  become , the timer is invalid.

If you set the start time later than the end time or the temperature out of range of the mode. The following page will appear:

SCHEDULE			
TIMER	WEEKLY SCHEDULE	SCHEDULE CHECK	CANCEL TIMER
Timer1 is useless.			
Please check the timer setting and temperature setting.			
OK CONFIRM			

## Example:

Six timer is set as following:

NO.	START	END	MODE	TEMP
T1	1: 00	3: 00	DHW	50°C
T2	7: 00	9: 00	HEAT	28°C
T3	11: 30	13: 00	COOL	20°C
T4	14: 00	16: 00	HEAT	28°C
T5	15: 00	19: 00	COOL	20°C
T6	18: 00	23: 30	DHW	50°C

The unit will run as following:

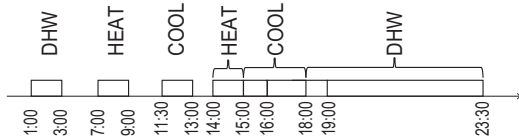

The operation of the controller at the following time:

TIME	The operatin of the controller
1: 00	DHW mode is turned ON
3: 00	DHW mode is turned OFF
7: 00	HEAT MODE is turned ON
9: 00	HEAT MODE is turned OFF
11: 30	COOL MODE is turned ON
13: 00	COOL MODE is turned OFF
14: 00	HEAT MODE is turned ON
15: 00	COOL MODE is turned ON and HEAT MODE is turned OFF
18: 00	DHW MODE is turned ON and COOL MODE is turned OFF
23: 30	DHW mode is turned OFF

### **i** INFORMATION

If the start time is same to the end time in one timer, the timer is invalid.

## 6.4.2 Weekly schedule

If the timer function is on and the weekly schedule is off, the later setting is effective. If WEEKLY SCHEDULE is activated, **7** is displayed on the home page.

Go to "MENU" > "SCHEDULE" > "WEEKLY SCHEDULE". Press "OK". The following page will appear:

SCHEDULE			
TIMER	WEEKLY SCHEDULE	SCHEDULE CHECK	CANCEL TIMER
MON.	TUE.	WED.	THU. FRI. SAT. SUN.
<input checked="" type="checkbox"/>	<input type="checkbox"/>	<input type="checkbox"/>	<input type="checkbox"/>
ENTER		CANCEL	
OK MON SELECT		<input type="button" value="↕"/> <input type="button" value="↔"/>	

First select the days of the week you wish to schedule. Use "◀", "▶" to scroll, press "OK" to select on unselect the day.

"**MON**" means that the day is selected, "MON" means that the day is unselected.

### **i** INFORMATION

We must set two days at least when we want to enable WEEKLY SCHEDULE function.

SCHEDULE			
TIMER	WEEKLY SCHEDULE	SCHEDULE CHECK	CANCEL TIMER
MON.	TUE.	WED.	THU. FRI. SAT. SUN.
<input type="checkbox"/>	<input type="checkbox"/>	<input type="checkbox"/>	<input checked="" type="checkbox"/>
ENTER		CANCEL	
OK MON SELECT		<input type="button" value="↕"/> <input type="button" value="↔"/>	

Use "◀" or "▶" to SET, press "ENTER". The Monday to Friday are selected to be scheduled and they have the same schedule.

The following pages will appear:

SCHEDULE				1/2
TIMER	WEEKLY SCHEDULE	SCHEDULE CHECK	CANCEL TIMER	
NO.	START	END	MODE	TEMP
<b>1</b>	<input type="checkbox"/> 00:00	<input type="checkbox"/> 00:00	HEAT	0°C
2	<input type="checkbox"/> 00:00	<input type="checkbox"/> 00:00	HEAT	0°C
3	<input type="checkbox"/> 00:00	<input type="checkbox"/> 00:00	HEAT	0°C
				<input type="button" value="↕"/> <input type="button" value="↔"/>

SCHEDULE				2/2
TIMER	WEEKLY SCHEDULE	SCHEDULE CHECK	CANCEL TIMER	
NO.	START	END	MODE	TEMP
<b>4</b>	<input type="checkbox"/> 00:00	<input type="checkbox"/> 00:00	HEAT	0°C
5	<input type="checkbox"/> 00:00	<input type="checkbox"/> 00:00	HEAT	0°C
6	<input type="checkbox"/> 00:00	<input type="checkbox"/> 00:00	HEAT	0°C
				<input type="button" value="↕"/> <input type="button" value="↔"/>

Use "◀", "▶", "▼", "▲" to scroll and adjust the time, the mode and the temperature. Timers can be set, including start time and end time, mode and temperature. The mode includes heat mode, cool mode and DHW mode.

The setting method refer to timer setting. The end time must be later than the start time. Otherwise this will show that Timer is useless.



### 6.4.3 Schedule check

schedule check can only check the weekly schedule.

Go to "MENU" > "SCHEDULE" > "SCHEDULE' CHECK". Press "OK". The following page will appear:

SCHEDULE			
TIMER	WEEKLY SCHEDULE	SCHEDULE CHECK	CANCLE TIMER
WEEKLY SCHEDULE CHECK			
OK ENTER		↕ ↔	

WEEKLY SCHEDULE CHECK					
DAY	NO	MODE	SET	START	END
MON <input type="checkbox"/>	T1	<input type="checkbox"/> HEAT	0°C	00:00	00:00
	T2	<input type="checkbox"/> HEAT	0°C	00:00	00:00
	T3	<input type="checkbox"/> HEAT	0°C	00:00	00:00
	T4	<input type="checkbox"/> HEAT	0°C	00:00	00:00
	T5	<input type="checkbox"/> HEAT	0°C	00:00	00:00
	T6	<input type="checkbox"/> HEAT	0°C	00:00	00:00

Press "▼", "▲", the timer from Monday to Sunday will appear:

### 6.4.4 CANCEL TIMER

Go to "MENU" > "SCHEDULE" > "CANCEL TIMER". Press "OK". The following page will appear:

SCHEDULE			
TIMER	WEEKLY SCHEDULE	SCHEDULE CHECK	CANCLE TIMER
Do you want to cancel the timer and weekly schedule?			
NO		YES	
OK ENTER		↕ ↔	

Use "◀", "▶", "▼", "▲" to move to "YES", press "OK" to cancel timer. If you want to exit CANCEL TIMER, press "BACK".

If TIMER or WEEKLY SCHEDULE is activated, timer icon "🕒" or weekly schedule icon "7" will display on the home page.

01-01-2018 🗓	23:59	🕒	🏠 13°
🌊	ON	🚰	
23.5 °C	☀️	38 °C	

If TIMER or WEEKLY SCHEDULE is canceled, icon "🕒" or "7" will disappear on the home page.

01-01-2018 🗓	23:59	🏠 13°
🌊	ON	🚰
23.5 °C	☀️	38 °C

#### **i** INFORMATION

You have to reset TIMER/WEEKLY SCHEDULE, if you change the WATER FLOW TEMP. to the ROOM TEMP. or you change the ROOM TEMP. to the WATER FLOW TEMP. The TIMER or WEEKLY SCHEDULE is invalid, if ROOM THERMOSTAT is effect.

#### **i** INFORMATION

- The ECO has the highest priority, the TIMER or WEEKLY SCHEDULE has the second priority and the PRESET TEMP. or WEATHER TEMP. SET has the lowest priority.
- The PRESET TEMP. or WEATHER TEMP. SET becomes invalid, when we set the ECO valid. We must reset the PRESET TEMP. or WEATHER TEMP. SET when we set the ECO invalid.
- TIMER or WEEKLY SCHEDULE is invalid when ECO is valid. TIMER or WEEKLY SCHEDULE is activated when the ECO is not running.
- TIMER and WEEKLY SCHEDULE are on the same priority. The later setting function is valid. The PRESET TEMP. becomes invalid when TIMER or WEEKLY SCHEDULE is valid. The WEATHER TEMP. SET is not affected by the setting of TIMER or WEEKLY SCHEDULE.
- PRSET TEMP. and WATHER TEMP.SET are on the same priority. The later setting function is valid.

#### **i** INFORMATION

All about the time set items(PRESET TEMP. , ECO DISINFECT, DHW PUMP, TIMER, WEEKLY SCHEDULE, SILENCE MODE , HOLIDAY HOME), the ON/OFF of the corresponding function can be activated from the start time to the end time.

## 6.5 Options

OPTIONS menu contents as following:

- 1) SILENT MODE
- 2) HOLIDAY AWAY
- 3) HOLIDAY HOME
- 4) BACKUP HEATER

### 6.5.1 Silent Mode

The SILENT MODE is used to decrease the sound of the unit. However, it also decreases the heating/cooling capacity of the system. There are two silent mode levels. level2 is more silent than level1, and the heating or cooling capacity is also more decreasing.

There are two method to use the silent mode:

- 1) silent mode in all time;
- 2) silent mode in timer.

- Go to the home page to check if silent mode is activated. If the silent mode is activated, "☾\*" will display on the home page.

- Go to "MENU" > "OPTIONS" > "SILENT MODE". Press "OK". The following page will appear:

OPTIONS				1/2
SILENT MODE	HOLIDAY AWAY	HOLIDAY HOME	BACKUP HEATER	
CURRENT STATE				OFF
SILENT LEVEL				LEVEL 1
TIMER1 START				12:00
TIMER1 END				15:00
ON/OFF				ON/OFF

Use "ON/OFF" to select ON or OFF.

Description:

If CURRENT STATE is OFF, SILENT MODE is invalid.

When you select SILENT LEVEL, and press "OK" or "▶". The following page will appear:

OPTIONS				
SILENT MODE	HOLIDAY AWAY	HOLIDAY HOME	BACKUP HEATER	
CURRENT STATE				ON
SILENT LEVEL				LEVEL 1
TIMER1 START				12:00
TIMER1 END				15:00
ADJUST				

LEVEL 1

OPTIONS				
SILENT MODE	HOLIDAY AWAY	HOLIDAY HOME	BACKUP HEATER	
CURRENT STATE				ON
SILENT LEVEL				LEVEL 2
TIMER1 START				12:00
TIMER1 END				15:00
ADJUST				

LEVEL 2

You can use "▼", "▲" to select level 1 or level 2. Press "OK".

If the silent TIMER is selected, Press "OK" to enter, the following page will appear.

OPTIONS				2/2
SILENT MODE	HOLIDAY AWAY	HOLIDAY HOME	BACKUP HEATER	
TIMER1				OFF
TIMER2 START				22:00
TIMER2 END				07:00
TIMER2				OFF
ADJUST				

There are two timers for setting. Move to "■", press "OK" to select or unselect.

If the two time are both unselected, the silent mode will operate in all time. Otherwise, it will operate according as the time.

### 6.5.2 Holiday Away

- If the holiday away mode is activated, "☾" will display on the home page.

The holiday away function is used to prevent frozen in the winter during the outside holiday, and return the unit before the end of the holiday.

Go to "MENU" > "OPTIONS" > "HOLIDAY AWAY". Press "OK". The following page will appear:

OPTIONS				1/2
SILENT MODE	HOLIDAY AWAY	HOLIDAY HOME	BACKUP HEATER	
CURRENT STATE				OFF
DHW MODE				ON
DISINFECT				ON
HEAT MODE				ON
ON/OFF				ON/OFF

OPTIONS				2/2
SILENT MODE	HOLIDAY AWAY	HOLIDAY HOME	BACKUP HEATER	
FROM				00-00-2000
UNTIL				00-00-2000
ADJUST				

Usage example: You go away during the winter. The current date is 2018-01-31, two days later is 2018-02-02, it is the beginning date of the holiday.

- If you are in the following situation:
  - In 2 days, you go away for 2 weeks during the winter.
  - You want to save energy, but prevent your house from freezing.



Use "ON/OFF" to select "OFF" or "ON" .

### **i** INFORMATION

- If the operation mode is auto mode in space heating or cooling side, the backup heater function can not be selected.
- The BACKUP HEATER function is invalid when only ROOM HEAT MODE enabled.

## 6.6 Child Lock

The CHILD Lock function is used to prevent children error operation. The mode setting and temperature adjusting can be locked or unlocked by using CHILD LOCK function. Go to " MENU " > "CHILD LOCK". The page is displayed:

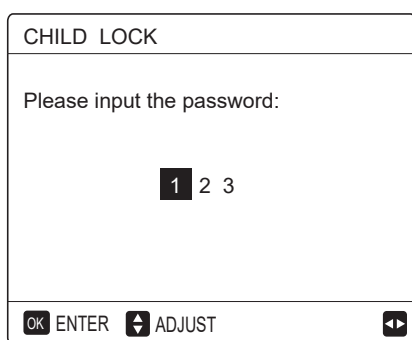

Input the current password, the following page will appear:

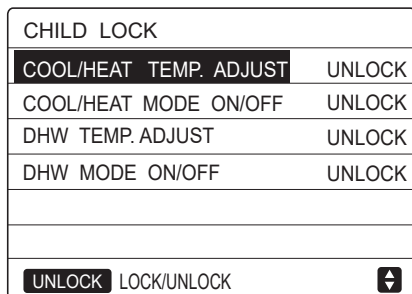

Use "▼", "▲" to scroll and "ON/OFF" to select LOCK or UNLOCK.

The cool/heat temperature can't be adjusted when the COOL/HEAT TEMP. ADJUST is locked. If you want to adjust the cool/heat temperature when cool/heat temperature is locked, the following page will appear:

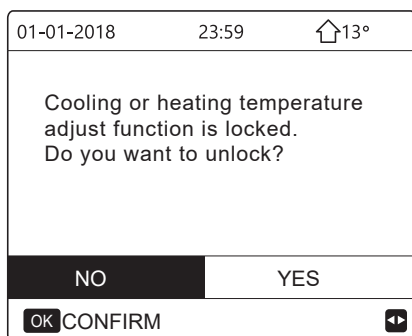

The cool/heat mode can't turn on or off when the COOL/HEAT MODE ON/OFF is locked. If you want to turn on or off the cool/heat mode when COOL/HEAT MODE ON/OFF is locked, the following page will appear:

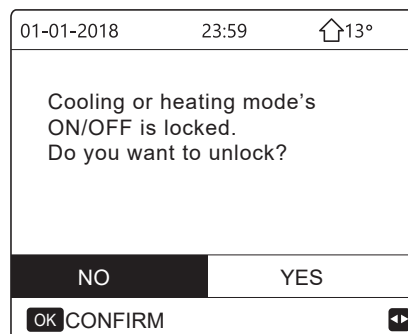

The DHW temperature can't be adjusted when the DHW TEMP. ADJUST is locked. If you want to adjust the DHW temperature when DHW TEMP. ADJUST is locked, the following page will appear:

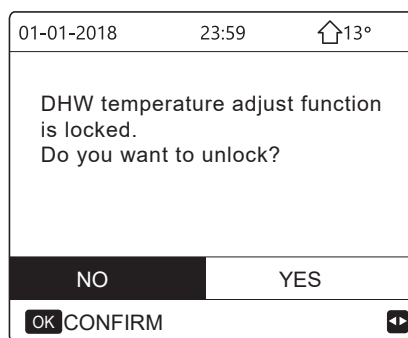

The DHW mode can't turn on or off when the DHW MODE ON/OFF is locked. If you want to turn on or off the DHW mode when DHW MODE ON/OFF is locked, the following page will appear:

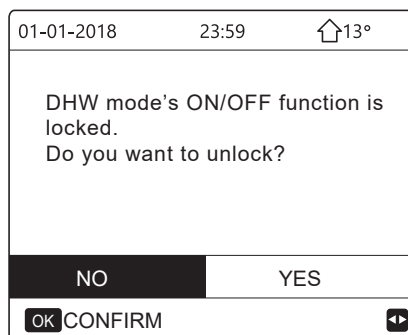

## 6.7 Service information

### 6.7.1 About service information

Service information menu contents as following:

- 1) SERVICE CALL
- 2) ERROR CODE
- 3) PARAMETER
- 4) DISPLAY

### 6.7.2 How to go to service information menu

- Go to "MENU" > "SERVICE INFORMATION". Press "OK". The following page will appear:

The service call can show the service phone or mobile number. The installer can input the phone number. See "FOR SERVICEMAN".

SERVICE INFORMATION			
SERVICE CALL	ERROR CODE	PARAMETER	DISPLAY
PHONE NO.	00000000000000		
MOBILE NO.	00000000000000		

Error code is used to show when the fault or protection happens and show the meaning of the error code.

SERVICE INFORMATION			
SERVICE CALL	ERROR CODE	PARAMETER	DISPLAY
E2	#00	14:10	01-01-2018
E2	#00	14:00	01-01-2018
E2	#00	13:50	01-01-2018
E2	#00	13:20	01-01-2018
OK ENTER			

Press OK the page will appear:

SERVICE INFORMATION 1/2			
SERVICE CALL	ERROR CODE	PARAMETER	DISPLAY
E2	#00	14:10	01-01-2018
E2	#00	14:00	01-01-2018
E2	#00	13:50	01-01-2018
E2	#00	13:20	01-01-2018
OK ENTER			

press OK to show the meaning of the error code:

01-01-2018	23:59	🏠 13°
E2 communication fault between controller and indoor unit		
Please contact your dealer.		
OK CONFIRM		#00

### **i** INFORMATION

A total of eight fault codes can be recorded.

The parameter function is used to display the main parameter, there are two pages to show the parameter:

SERVICE INFORMATION 1/2			
SERVICE CALL	ERROR CODE	PARAMETER	DISPLAY
		ROOM SET TEMP.	26°C
		MAIN SET TEMP.	55°C
		TANK SET TEMP.	55°C
		ROOM ACTUAL TEMP.	24°C

SERVICE INFORMATION 2/2			
SERVICE CALL	ERROR CODE	PARAMETER	DISPLAY
		MAIN ACTUAL TEMP.	26°C
		TANK ACTUAL TEMP.	55°C
		SMART GRID RUNNING TIME	0 Hrs

The DISPLAY function is used to set the interface:

SERVICE INFORMATION 1/2			
SERVICE CALL	ERROR CODE	PARAMETER	DISPLAY
		TIME	12:30
		DATE	08-08-2018
		LANGUAGE	EN
		BACKLIGHT	ON
OK ENTER			

SERVICE INFORMATION 2/2			
SERVICE CALL	ERROR CODE	PARAMETER	DISPLAY
		BUZZER	ON
		SCREEN LOCK TIME	120SEC
		SMART GRID RUNNING TIME	2 Hrs
ON/OFF ON/OFF			

Use "OK" to enter and use "◀", "▶", "▼", "▲" to scroll.

## 6.8 Operation Parameter

This menu is for installer or service engineer reviewing the operation parameter.

- At home page, go to "MENU" > "OPERATION PARAMETER".
- Press "OK". There are six pages for the operating parameter as following. Use "▼", "▲" to scroll.

OPERATION PARAMETER	#01
ONLINE UNITS NUMBER	1
OPERATE MODE	COOL
SV1 STATE	ON
SV2 STATE	OFF
SV3 STATE	OFF
PUMP_I	ON
ADDRESS	1/9

OPERATION PARAMETER	#01
PUMP_O	OFF
PUMP_C	OFF
PUMP_S	OFF
PUMP_D	OFF
PIPE BACKUP HEATER	OFF
TANK BACKUP HEATER	ON
ADDRESS	2/9

OPERATION PARAMETER	#01
GAS BOILER	OFF
T1 LEAVING WATER TEMP.	35°C
WATER FLOW	1.72m3/h
HEAT PUMP CAPACTIY	11.52kW
POWER CONSUM	1000kWh
Ta ROOM TEMP.	25°C
ADDRESS	3/9

OPERATION PARAMETER	#01
T5 WATER TANK TEMP.	53°C
Tw2 CIRCUIT2 WATER TEMP.	35°C
TIS' C1 CLI. CURVE TEMP.	35°C
TIS2' C2 CLI. CURVE TEMP.	35°C
TW_O PLATE W-OUTLET TEMP.	35°C
TW_I PLATE W-INLET TEMP.	30°C
ADDRESS	4/9

OPERATION PARAMETER	#01
Tbt1 BUFFERTANK_UP TEMP.	35°C
Tbt2 BUFFERTANK_LOW TEMP.	35°C
Tsolar	25°C
IDU SOFTWARE	01-09-2019V01
ADDRESS	5/9

OPERATION PARAMETER	#01
ODU MODEL	6kW
COMP.CURRENT	12A
COMP.FREQUENCY	24Hz
COMP.RUN TIME	54 MIN
COMP.TOTAL RUN TIME	1000Hrs
EXPANSION VALVE	200P
ADDRESS	6/9

OPERATION PARAMETER	#01
FAN SPEED	600R/MIN
IDU TARGET FREQUENCY	46Hz
FREQUENCY LIMITED TYPE	5
SUPPLY VOLTAGE	230V
DC GENERATRIX VOLTAGE	420V
DC GENERATRIX CURRENT	18A
ADDRESS	7/9

OPERATION PARAMETER	#01
TW_O PLATE W-OUTLET TEMP.	35°C
TW_I PLATE W-INLET TEMP.	30°C
T2 PLATE F-OUT TEMP.	35°C
T2B PLATE F-IN TEMP.	35°C
Th COMP. SUCTION TEMP.	5°C
Tp COMP. DISCHARGE TEMP.	75°C
ADDRESS	8/9

OPERATION PARAMETER	#01
T3 OUTDOOR EXCHANGE TEMP.	5°C
T4 OUTDOOR AIR TEMP.	5°C
TF MODULE TEMP.	55°C
P1 COMP. PRESSURE	2300kPa
ODU SOFTWARE	01-09-2018V01
HMI SOFTWARE	01-09-2018V01
ADDRESS	9/9

### INFORMATION

The power consumption parameter is optional. If some parameter is not be activated in the system, the parameter will show "--". The heat pump capacity is for reference only, not used to judge the ability of the unit. The accuracy of sensor is  $\pm 1^\circ\text{C}$ . The flow rates parameters are calculated according to the pump running parameters, the deviation is different at different flow rates, the maximum of deviation is 15%. The flow parameters are calculated according to the electrical parameters of the pump operation. The operating voltage is different and the deviation is different. The display value is 0 when the voltage is less than 198V.

## 6.9 For Serviceman

### 6.9.1 About For Serviceman

FOR SERVICEMAN is used for installer and service engineer.

- Setting the function of equipment.
- Setting the parameters.

### 6.9.2 How To Go To For Serviceman

Go to "MENU" > "FOR SERVICEMAN". Press "OK".

FOR SERVICEMAN	
Please input password:	
2 3 4	
OK ENTER	ADJUST

- The FOR SERVICEMAN is used for installer or service engineer. It is NOT intended the home owner alters setting with this menu.
- It is for this reason password protection is required to prevent unauthorised access to the service settings.
- The password is 234.

### 6.9.3 How To Exit For SERVICEMAN

If you have set all the parameter.  
Press "BACK", the following page will appear:

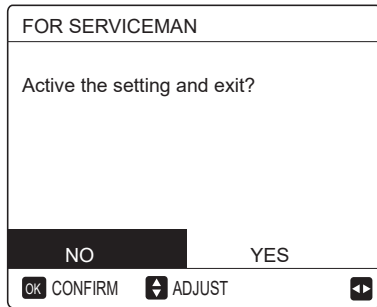

Select "YES" and press "OK" to exit the FOR SERVICEMAN.  
After exiting the FOR SERVICEMAN, the unit will be turned off.

## 6.10 Network Configuration Guidelines

- The wired controller realizes intelligent control with a built-in module, which receives control signal from the APP.
- Before connecting the WLAN, please check for it if the router in your environment is active and make sure that the wired controller is well-connected to the wireless signal.
- During the Wireless distribution process, the LCD icon "📶" flashes to indicate that the network is being deployed. After the process is completed, the icon "📶" will be constantly on.

### 6.10.1 Wired Controller Setting

The wired controller settings include AP MODE and RESTORE WLAN SETTING.

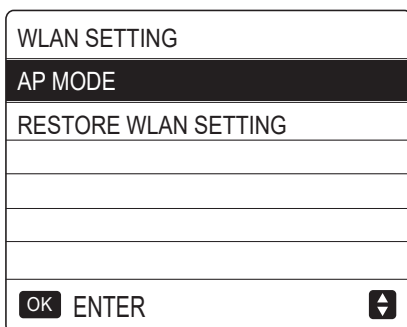

- Activate the WLAN by interface. Go to "MENU"> "WLAN SETTING"> "AP MODE".  
Press "OK", the following page will appear:

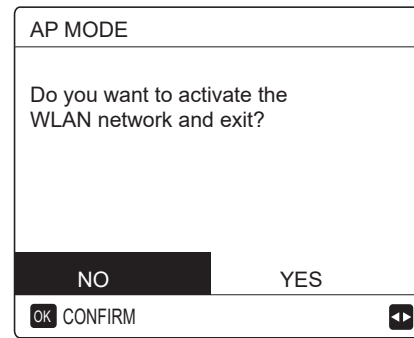

Use "◀", "▶" to move to "YES", press "OK" to select AP mode.  
Select AP Mode correspondingly on the mobile device and continue the follow-up settings according to the APP prompts.

### ⚠ CAUTION

After enter Ap mode, if it's not connected with mobile phone, the LCD icon "📶" will flash 10 minutes then disappear.

If it's connected with the mobile phone, the icon "📶" will be constantly display.

- Restore WLAN setting by interface. Go to "MENU"> "WLAN SETTING"> "RESTORE WLAN SETTING".  
Press "OK", the following page will appear:

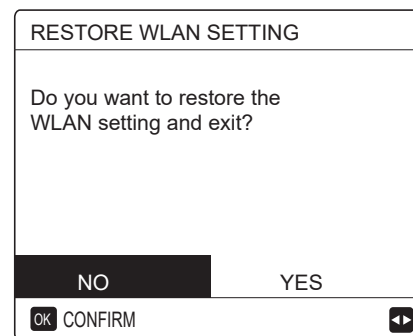

Use "◀", "▶" to move to "YES", press "OK" to restore WLAN setting. Complete the above operation and wireless configuration is reset.

- AP Mode connecting WLAN:

### 6.10.2 Mobile Device Setting

- ① AP Mode is available for wireless distribution on mobile device side.

#### (1) Install APP

Scan the following QR code to install the Smart Home APP.



② Please research "Msmartlife" in APP STORE or GOOGLE PLAY to install the APP.  
 (This APP is only applicable to Android 7.0 and IOS7, or newer operation systems.)

(2) Sign in/Sign up

Click the "+" button on the right side of the home page , register account according to the guide.

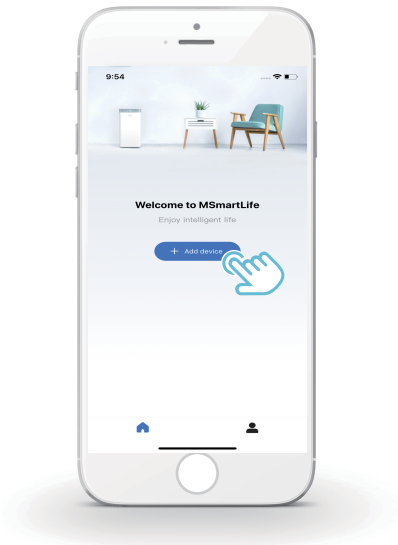

6.10.3 Add Home Appliances:

1 Choose the wired controller model, then go to add the device.

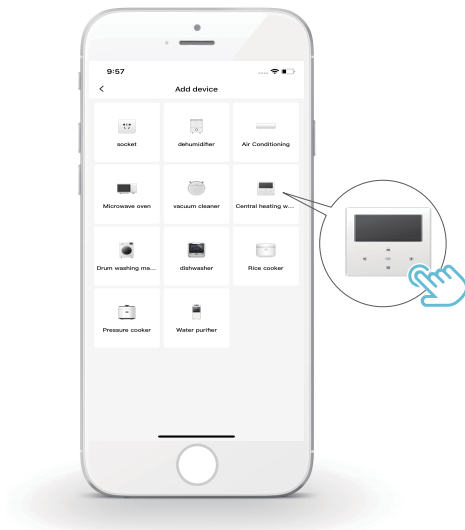

2) Operate the wired controller according to APP prompts.

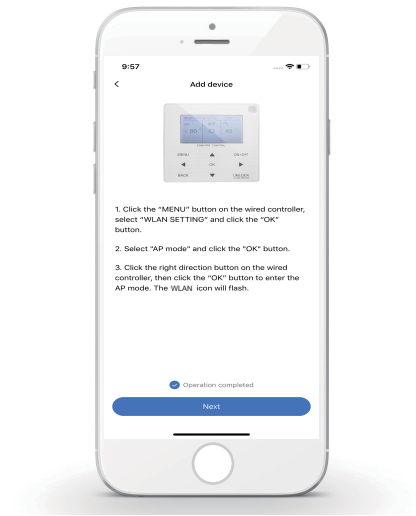

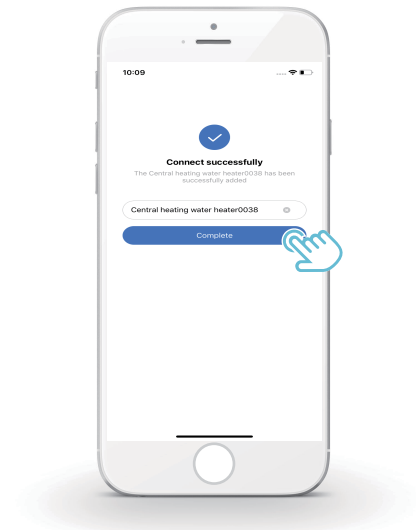

3) Wait for the home appliance to connect, and click "Finish".



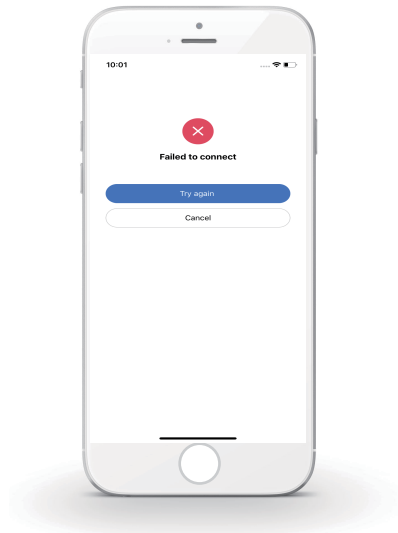

- 4) After the appliance is successfully connected, the LCD icon“” of the wired controller is constantly on, and the air conditioner can be controlled through the APP.
- 5) If the network distribution process fails, or the mobile connection demands reconnection and replacement, operate “WLAN Factory Reset” on the wired controller, and then repeat the above process.



** Warning and troubleshooting for networking failures**

When the product is connected to the network, please make sure that the phone is as close as possible to the product.

We only support 2.4GHz band routers at present.

Special characters (punctuation, spaces, etc.) are not recommended as part of the WLAN name.

It is recommended that you connect no more than 10 devices to a single router lest home appliances are affected by weak or unstable network signal.

If the password of the router or WLAN is changed, clear all settings and reset the appliance.

The contents of APP might change in version updates and actual operation shall prevail.

**6.11 SN VIEW**

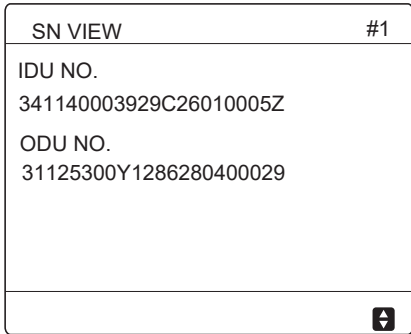
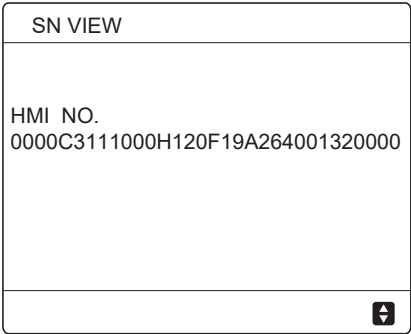

# 7 MENU STRUCTURE : OVERVIEW

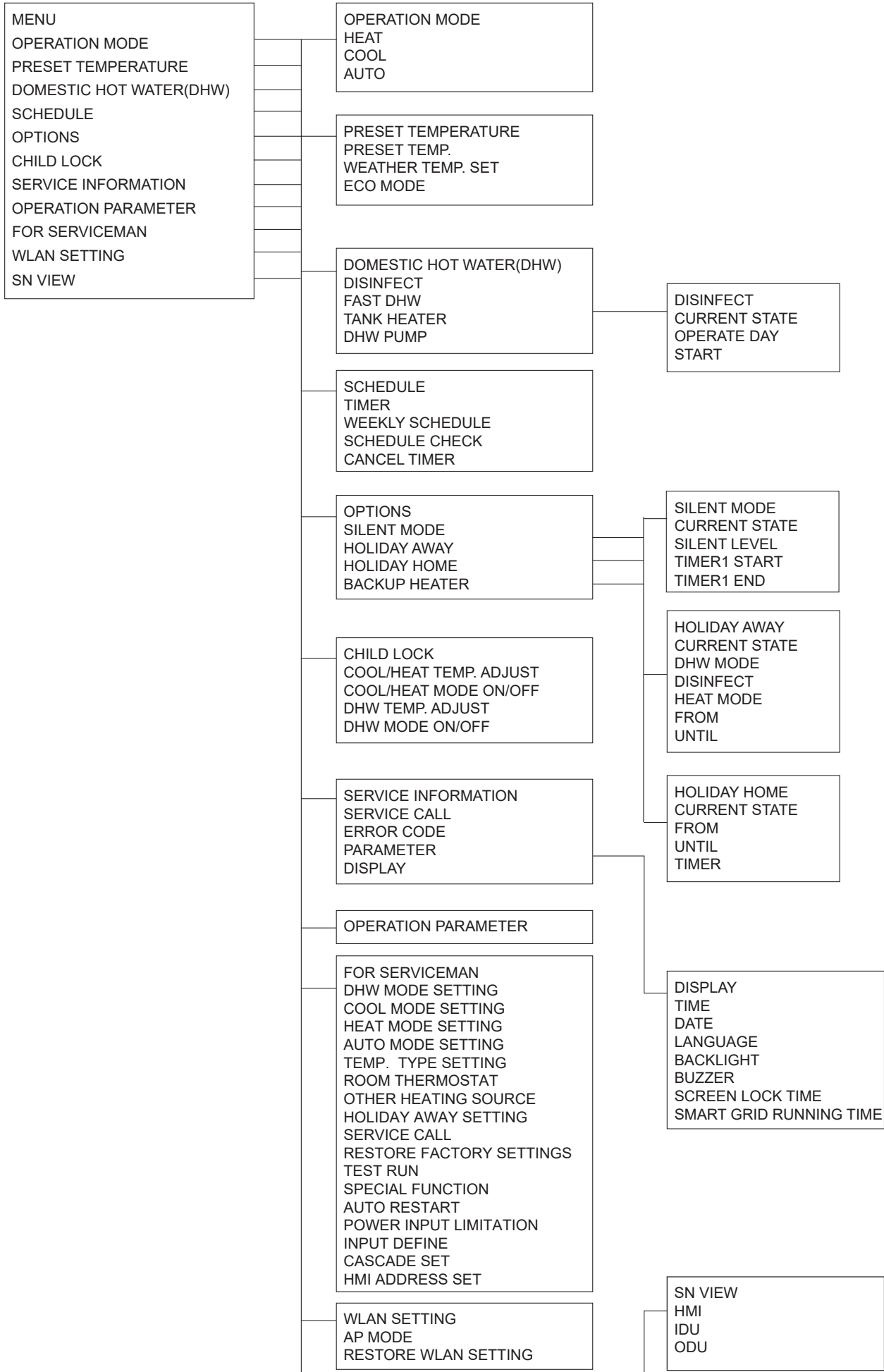

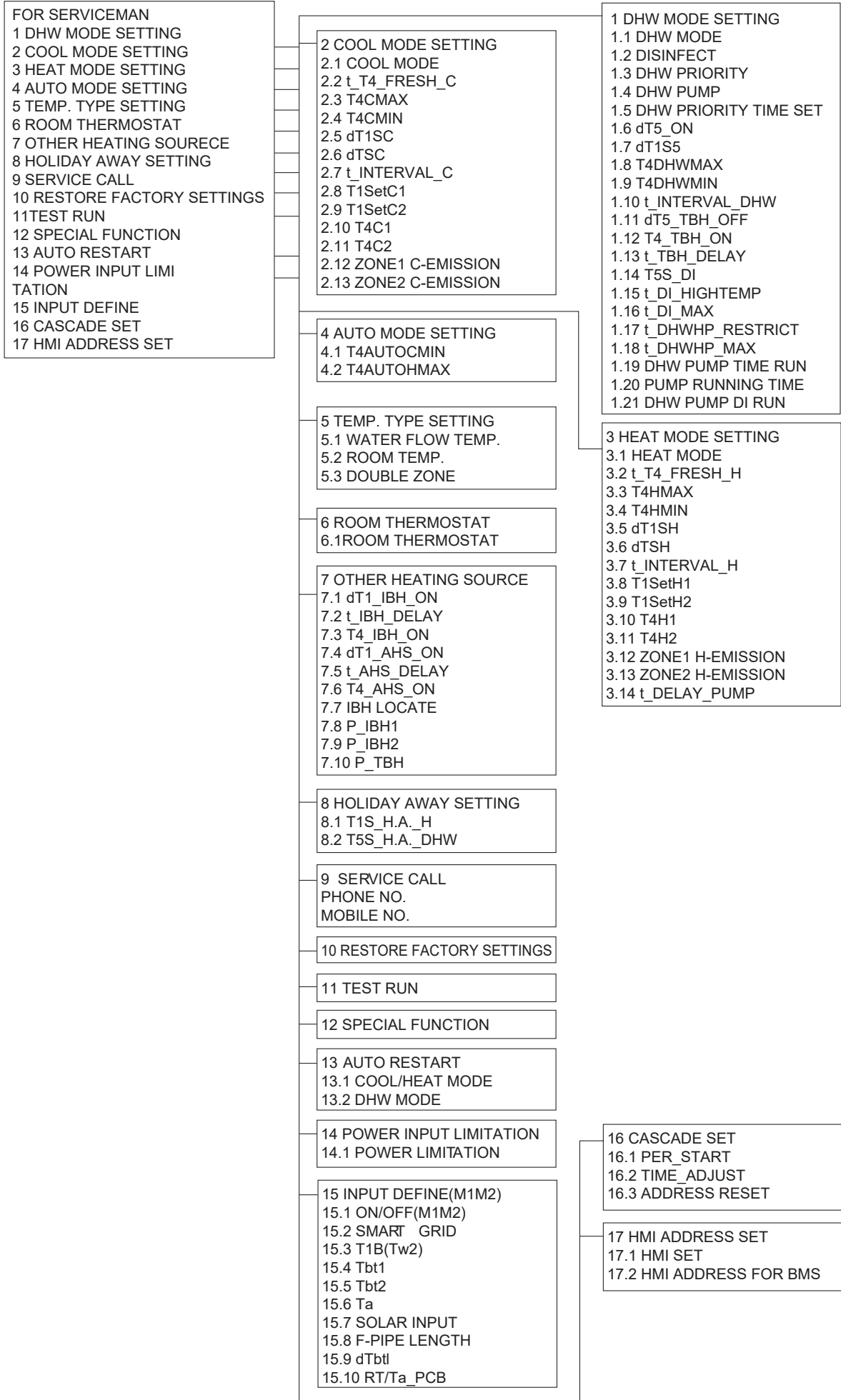

Table1 The environment temperature curve of the low temperature setting for heating

T4	≤ -20	-19	-18	-17	-16	-15	-14	-13	-12	-11	-10	-9	-8	-7	-6	-5	-4	-3	-2	-1	0
1-T1S	38	38	38	38	38	37	37	37	37	37	37	36	36	36	36	36	36	35	35	35	35
2-T1S	37	37	37	37	37	36	36	36	36	36	36	35	35	35	35	35	35	34	34	34	34
3-T1S	36	36	36	35	35	35	35	35	35	34	34	34	34	34	34	33	33	33	33	33	33
4-T1S	35	35	35	34	34	34	34	34	34	33	33	33	33	33	33	32	32	32	32	32	32
5-T1S	34	34	34	33	33	33	33	33	33	32	32	32	32	32	32	31	31	31	31	31	31
6-T1S	32	32	32	32	31	31	31	31	31	31	31	31	30	30	30	30	30	30	30	30	29
7-T1S	31	31	31	31	30	30	30	30	30	30	30	30	29	29	29	29	29	29	29	29	28
8-T1S	29	29	29	29	28	28	28	28	28	28	28	28	27	27	27	27	27	27	27	27	26
T4	1	2	3	4	5	6	7	8	9	10	11	12	13	14	15	16	17	18	19	≥ 20	
1-T1S	35	35	34	34	34	34	34	34	33	33	33	33	33	33	32	32	32	32	32	32	32
2-T1S	34	34	33	33	33	33	33	33	32	32	32	32	32	32	31	31	31	31	31	31	31
3-T1S	32	32	32	32	32	32	31	31	31	31	31	31	30	30	30	30	30	30	29	29	29
4-T1S	31	31	31	31	31	31	30	30	30	30	30	30	29	29	29	29	29	29	28	28	28
5-T1S	30	30	30	30	30	30	29	29	29	29	29	29	28	28	28	28	28	28	27	27	27
6-T1S	29	29	29	29	29	29	28	28	28	28	28	28	27	27	27	27	27	27	26	26	26
7-T1S	28	28	28	28	28	28	27	27	27	27	27	27	26	26	26	26	26	26	25	25	25
8-T1S	26	26	26	26	26	26	26	25	25	25	25	25	25	25	25	24	24	24	24	24	24

Table2 The environment temperature curve of the high temperature setting for heating

T4	≤ -20	-19	-18	-17	-16	-15	-14	-13	-12	-11	-10	-9	-8	-7	-6	-5	-4	-3	-2	-1	0
1-T1S	55	55	55	55	54	54	54	54	54	54	54	54	53	53	53	53	53	53	53	53	52
2-T1S	53	53	53	53	52	52	52	52	52	52	52	52	51	51	51	51	51	51	51	51	50
3-T1S	52	52	52	52	51	51	51	51	51	51	51	51	50	50	50	50	50	50	50	50	49
4-T1S	50	50	50	50	49	49	49	49	49	49	49	49	48	48	48	48	48	48	48	48	47
5-T1S	48	48	48	48	47	47	47	47	47	47	47	47	46	46	46	46	46	46	46	46	45
6-T1S	45	45	45	45	44	44	44	44	44	44	44	44	43	43	43	43	43	43	43	43	42
7-T1S	43	43	43	43	42	42	42	42	42	42	42	42	41	41	41	41	41	41	41	41	40
8-T1S	40	40	40	40	39	39	39	39	39	39	39	39	38	38	38	38	38	38	38	38	37
T4	1	2	3	4	5	6	7	8	9	10	11	12	13	14	15	16	17	18	19	≥ 20	
1-T1S	52	52	52	52	52	52	52	51	51	51	51	51	51	51	51	50	50	50	50	50	50
2-T1S	50	50	50	50	50	50	50	49	49	49	49	49	49	49	49	48	48	48	48	48	48
3-T1S	49	49	49	49	49	49	49	48	48	48	48	48	48	48	47	47	47	47	47	47	47
4-T1S	47	47	47	47	47	47	47	46	46	46	46	46	46	46	46	45	45	45	45	45	45
5-T1S	45	45	45	45	45	45	45	44	44	44	44	44	44	44	44	43	43	43	43	43	43
6-T1S	42	42	42	42	42	42	42	41	41	41	41	41	41	41	41	40	40	40	40	40	40
7-T1S	40	40	40	40	40	40	40	39	39	39	39	39	39	39	39	38	38	38	38	38	38
8-T1S	37	37	37	37	37	37	37	36	36	36	36	36	36	36	36	35	35	35	35	35	35

The automatic setting curve

The automatic setting curve is the ninth curve, this is the calculation:

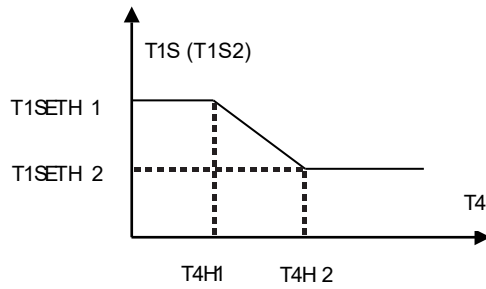

State: In the setting the wired controller, if  $T4H2 < T4H1$ , then exchange their value; if  $T1SETH1 < T1SETH2$ , then exchange their value.

Table3 The environment temperature curve of the low temperature setting for cooling

T4	$-10 \leq T4 < 15$	$15 \leq T4 < 22$	$22 \leq T4 < 30$	$30 \leq T4$
1- T1S	16	11	8	5
2- T1S	17	12	9	6
3- T1S	18	13	10	7
4- T1S	19	14	11	8
5- T1S	20	15	12	9
6- T1S	21	16	13	10
7- T1S	22	17	14	11
8- T1S	23	18	15	12

Table4 The environment temperature curve of the high temperature setting for cooling

T4	$-10 \leq T4 < 15$	$15 \leq T4 < 22$	$22 \leq T4 < 30$	$30 \leq T4$
1- T1S	20	18	17	16
2- T1S	21	19	18	17
3- T1S	22	20	19	17
4- T1S	23	21	19	18
5- T1S	24	21	20	18
6- T1S	24	22	20	19
7- T1S	25	22	21	19
8- T1S	25	23	21	20

The automatic setting curve

The automatic setting curve is the ninth curve, this is the calculation:

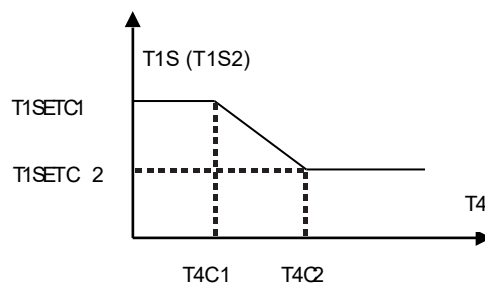

State: In the setting the wired controller, if  $T4C2 < T4C1$ , then exchange their value; if  $T1SETC1 < T1SETC2$ , then exchange their value.